

7.3 Volume By Shells

$$V_{\text{shell}} = 2\pi(\text{radius})(\text{altitude})(\text{thickness})$$

x-axis $V_{\text{shell}} = 2\pi \int_c^d y(f(y) - g(y)) dy$

where y is the radius and

$(f(y) - g(y))$ is the altitude (or height)

y-axis $V_{\text{shell}} = 2\pi \int_a^b x(f(x) - g(x)) dx$

where x is the radius and

$(f(x) - g(x))$ is the altitude (or height)

1. $y = x + 1$, $y = (x - 1)^2$,
rotated around the y -axis

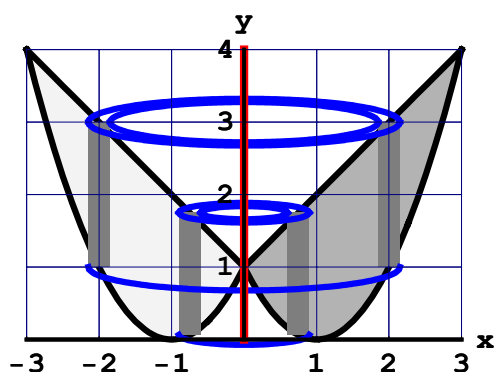

2. $y = 2x - x^2$, $y = 0$,
rotated around the y -axis

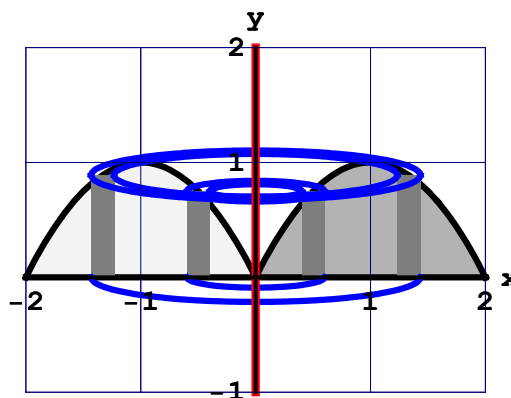

3. $y = \frac{1}{2}x + \frac{1}{2}$, $y = \frac{1}{x^2}$, and $x = 3$,
rotated around the y -axis

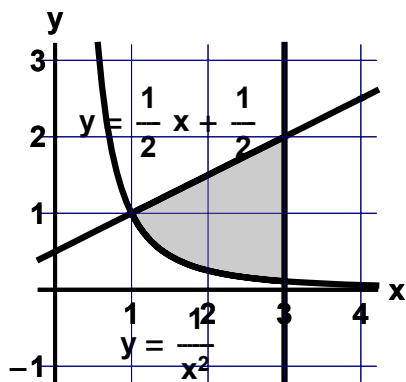

4. $y = \frac{1}{2}x$, $y = 0$, and $x = 4$,
rotated around the x -axis

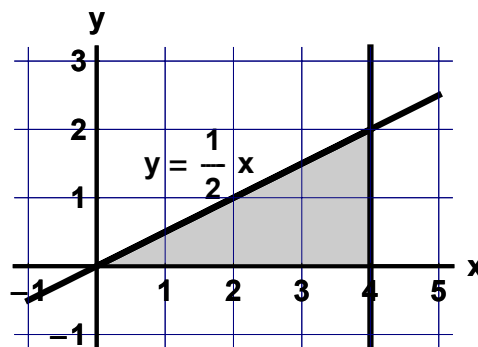

5. $y = 2x$, $y = \frac{1}{8}x^3$, rotated around the y -axis

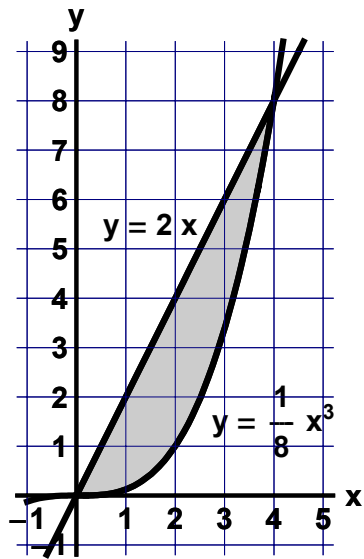

6. $y = -x^3$, and $y = -\sqrt{x}$, rotated around the x -axis

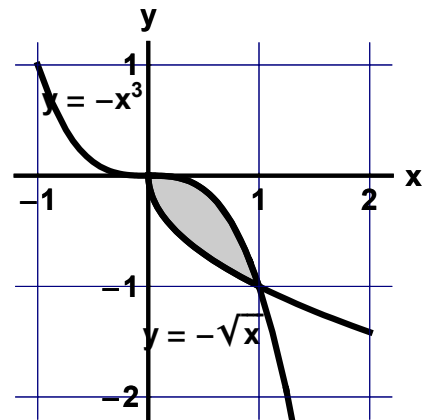

7. $y = \cos x$, $y = \sin x$, and $x = 0$, rotated around the y -axis

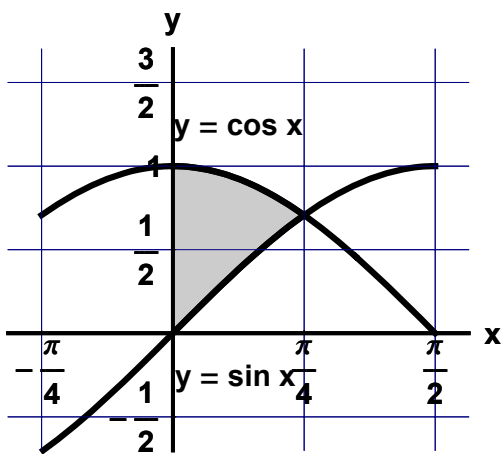

8. $x = y^{\frac{2}{3}}$, $x - y = 2$, $y = 2$, and $y = 8$, rotated around the x -axis

